

HOME OF CLAMPING



2022/2023
MAGNETIC CLAMPING SYSTEMS

WE GENERATE EXCITEMENT.

Since the foundation of the company in 1890 until today the goal has remained the same: the highest quality in products and services. Nevertheless, the circumstances, tasks and challenges have changed, of course. By focussing on our core areas of expertise, we have long set new standards for innovative clamping technology - driven by our own development, the greatest possible flexibility and passion for individual solutions.

All this is only possible with committed and contented employees. Respectful interaction with others, personal development and measures for the wellbeing of each individual are therefore values that matter to us.



Company Management:
Wolfgang Balle, Johannes Maier (CEO), Jürgen Förster

OUR COMPANY HISTORY

- 1890 Company founded as a lock manufacturer by Andreas Maier.
- 1920 Product range extended to include spanners.
- 1928 Production line assembly of FELLBACH LOCKS.
- 1951 Introduces clamping elements and diversifies into workpiece and tool clamping technology.
- 1965 Toggle clamps extend the AMF product range, AMF catalogues are now printed in ten languages.
- 1975 Further specialisation into hydraulic clamping technology.
- 1982 Clamping and fixture systems round off AMF's clamping expertise.
- 1996 AMF team organisation in all sectors of the business, Quality management with certification to ISO 9001.
- 2001 AMF Service Guarantee for all products.
- 2004 Introduction of the ZPS zero-point clamping system.
- 2007 The magnetic clamping technology extends the AMF product range.
- 2009 Development and marketing of AMF Vacuum clamping technology.
- 2012 LOW-COST AUTOMATION gripping, clamping, marking and cleaning.
- 2014 AMF presents the most extensive product range of automation solution in zero-point clamping technology.
- 2017 Wireless sensing systems extend the expertise into Industry 4.0 and blends seamlessly into the AMF product range.

PLEDGES THAT COUNT IN EVERYDAY LIFE

For this reason, we have a few principles that we follow by conviction and which always apply.

INDIVIDUAL DEVELOPMENT

Even if the product you need does not even exist yet, we will find the right solution with you: from special designs to new developments, everything is possible.

WARRANTY

If, despite our high quality standard, there is a complaint, this is dealt with quickly and unbureaucratically, even beyond the warranty period.

HIGHEST QUALITY STANDARDS

Careful manufacturing based on tradition since 1890, and naturally with a modern quality management system according to ISO 9001 for many years.

SHORT DELIVERY TIME

With over 5,000 articles in our warehouse, you can expect your order to be dispatched on the same day.

COMPETENT SERVICE FROM EXPERTS

Your local retail partner or the specialists in our team will find the right solution for every task.

MADE IN GERMANY

Our entire product range is developed and manufactured exclusively by our employees in Germany.

FUNCTIONAL PRINCIPLE, ADVANTAGES AND PERFORMANCE FEATURES OF AMF MAGNETIC CLAMPING TECHNOLOGY	4 - 9
--	--------------

MAGNETIC CLAMPING PLATES FOR MILLING	10 - 11
---	----------------



SPECIAL OFFER PACKAGES	12 - 13
-------------------------------	----------------

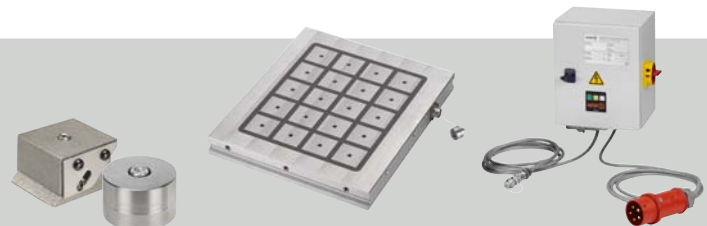

POLE EXTENSIONS	14 - 15
------------------------	----------------



CONTROL UNITS AND HAND-HELD CONTROLLERS	16 - 17
--	----------------

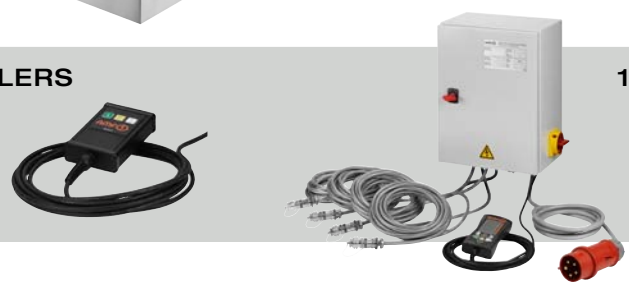

AMF MAGNETIC CLAMPING TECHNOLOGY - HIGH-PERFORMANCE AND SAFETY

Electromagnetic clamping systems were frequently connected with insecurity, unreliability, overheating or also a high need for maintenance. These disturbing characteristics are now a thing of the past. The innovative electro-permanent technology of the AMF magnetic clamping technology with its high-performance characteristics is permanently impressive. Behind it lie many years of experience, comprehensive know-how and the mission of offering customer-oriented solutions.

The result is convincing: High-quality square poles, arranged according to the chessboard principle, form the magnetic double cycle. An electromagnetic field is generated through the direct surrounding by pole-reversible permanent magnets on the sides and the magnets below the poles.

The square pole plates can be used in a targeted way – externally to magnetise workpieces or internally to separate the magnetic flow from the workpieces again. Activation or deactivation takes place in a fraction of a second. Moreover, a neutral crown allows complete magnetic insulation.

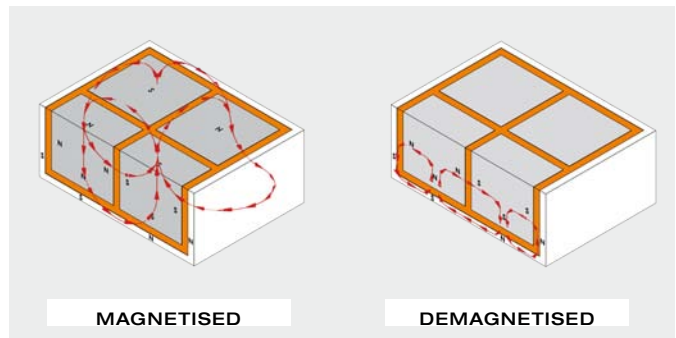

THE AMF MAGNETIC CLAMPING TECHNOLOGY COMPARED TO EXISTING SYSTEMS.

PERFECTION WITHOUT RESTRICTION.

With previous clamping systems, compromises frequently had to be accepted that, unfortunately, also had affects on the production process and productivity. The electro-permanent AMF magnetic clamping technology opens up completely new opportunities and completely eliminates multiple repositioning to carry out the work process as well as deformations or impairments due to clamps.

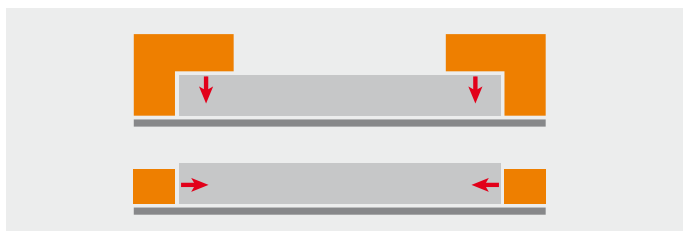

FREELY WORKABLE SURFACES AND UNIFORM CLAMPING.

The force of the magnetic field makes the decisive difference. For the magnetic surface on which the force is evenly distributed is used as a clamping area for the workpiece. And so all surfaces are completely accessible to be worked on without additional clamps and a simple 5-sided processing is possible without difficulty. A single procedure is sufficient for even clamping. The result is higher surface quality, higher precision and increased useful lives of the cutting materials.

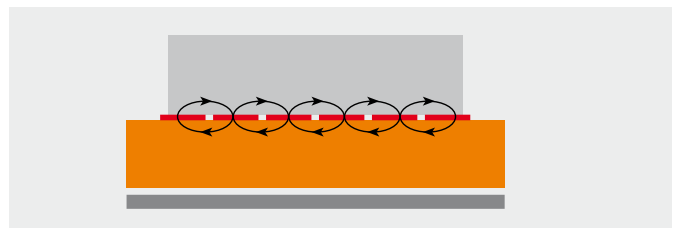

A GRIPPING SOLUTION - INNOVATIVE AND ECONOMICAL.

THE GRIPPING CONNECTION OF MULTIFACETED ADVANTAGES.

Based on the electro-permanent magnetism, the magnetic clamping plates from AMF impress with their high performance, safety, flexibility and efficiency.

Handling is convenient and fast; the range of uses for machine tools is unlimited. Even installation of the system is very simple, so that results show up very fast in application. And they contribute accordingly to fast payback of the investment. For optimisation of processes, improvement of the quality of results and reduction of processing times increase efficiency considerably.

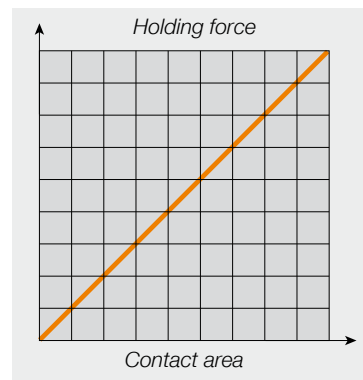

The high clamping strength and power of the magnetic clamping plates is developed uniformly, linearly and proportionally to the contact surface of the workpiece and remains constant over time, not tied to the processing phases.

THE BENEFITS AT A GLANCE!

PRODUCTIVITY

- > High clamping forces to 384 kN
- > Easy and quick positioning of the workpiece
- > Drastic reduction in set-up times
- > Facilitated interaction with CAD/CAM systems
- > Improved work sequence
- > Improved surface quality and tolerances
- > Material thickness of the magnetic clamping plates from 43 mm

SECURITY

- > Constant and concentrated force
- > No power consumption during clamping
- > Ergonomic in operation
- > No dispersion of magnetic flux
- > No interference

FLEXIBILITY

- > Repeatability of 0.01 mm
- > 5-side processing possible
- > All useful strokes used
- > Workpieces larger than the table surface are machinable
- > Simultaneous machining of multiple workpieces side by side
- > Simplified CNC or FMS programming

COST-EFFECTIVE

- > Limited capital outlay
- > No maintenance
- > No modification to the machine
- > Energy-saving
- > Reduced wear on tools
- > High value over time

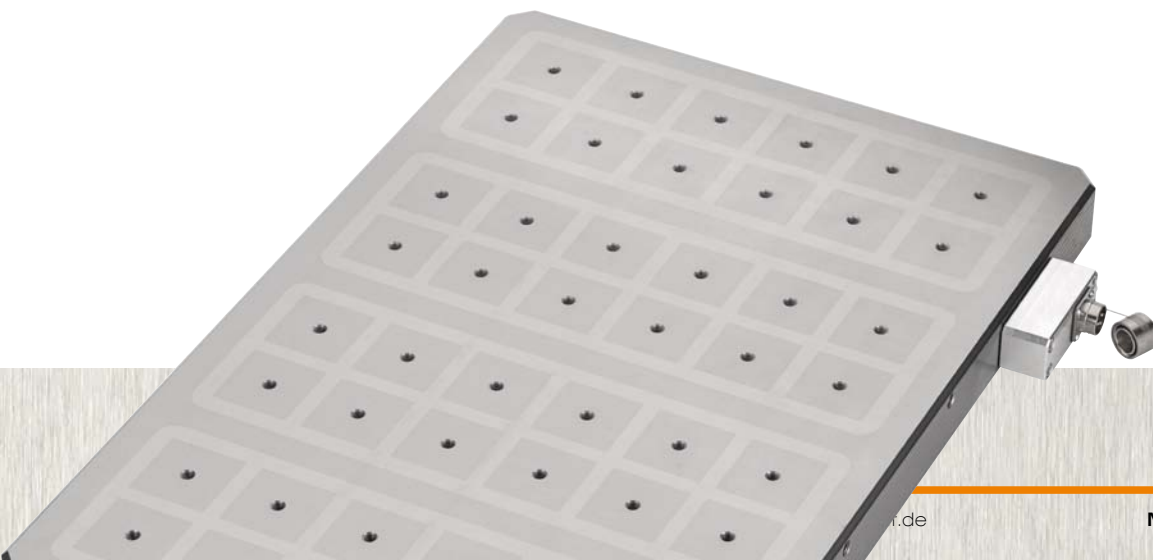

THE ABCS AND FAQs OF MAGNETIC CLAMPING TECHNOLOGY.

> WORKING TEMPERATURE:	Up to this temperature, a magnet can be used without irreversible magnetisation losses.
> CURIE TEMPERATURE:	At this temperature, magnetic materials lose their magnetisation irreversibly.
> FERROMAGNETIC MATERIAL:	All materials that exhibit magnetisation after application of an external magnetic field.
> MAGNETIC FIELD STRENGTH (A/M):	Amperes per meter (1A/m = 0.01256 oersted)
> MAGNETIC FLUX DENSITY (INDUCTION):	The change in a material that is induced by an applied magnetic field. Symbol: B / unit: T
> TESLA (T):	Unit of magnetic induction 1 T = 10 ⁴ Gauß
> GAUSS (G):	Outdated unit of magnetic induction.
> SATURATION MAX.:	The workpiece no longer absorbs any magnetisation.
> POLE EXTENSIONS:	Allow 5-side machining without interference contours.
> NEODYMIUM:	Magnetic material (NdFeB = Neodymium-Iron-Boron). They acquire a magnetic orientation during manufacture.
> ALNICO:	Magnetic material (Aluminium-Nickel-Cobalt)

WHAT HAPPENS IF THERE IS A POWER FAILURE?

The system is insensitive to possible power failures, and therefore „intrinsically safe“.

HOW CAN THE MAGNETIC CLAMPING PLATES BE FASTENED?

- a) laterally in the recesses with clamps (see catalogue „Mechanical clamping elements“)
- b) in combination with an adapter plate for the AMF zero-point clamping system

CAN I CLAMP ON ONE POLE?

At least two poles have to be covered in order for there to be a magnetic flux.
For optimal clamping, however, 4 poles should be covered.

WHAT HAPPENS IF I MILL INTO THE MAGNETIC CLAMPING PLATE?

The magnetic clamping plates can be reworked up to 4 mm by repeated re-grinding.
This also restores the plane parallelism.

WHAT PRECISION CAN I ACHIEVE WITH THIS SYSTEM?

Plane parallelism of up to 0.02 mm can be achieved by:

- 1) rough-milling the first surface
- 2) turning the plate over, rough-milling, stress-releasing and finishing the second plate
- 3) turning the plate over and finishing the first surface.

IS MECHANICAL DEFORMATION POSSIBLE DURING CLAMPING?

Quite the opposite. In the case of flame-cut parts, i.e. with very uneven workpiece surfaces, clamping is carried out with 3 fixed poles (3-point support) and with movable poles. The movable poles compensate for the unevenness, meaning that the workpiece is not deformed during clamping.

DO MAGNETIC FIELDS PRESENT ANY HAZARDS?

Magnetic field height 0 to 100 mm: In this area, cardiac pacemakers, wristwatches and bank cards may be damaged. At magnetic field height 100 mm and greater there is no longer any health risk.
 Caution! Do not put any workpieces on while the magnet is actively clamped. – risk of injury!

UP TO HOW MANY DEGREES CELSIUS CAN MAGNETIC TABLES BE USED?

The magnetic tables can be used at operating temperatures up to 100°C. The neodymium magnet is guaranteed for a maximum temperature of 100°C (this refers to the temperature in contact with the surface of the magnetic table over a longer time period). As a result of large temperature fluctuations, in some cases „magnetic edges“ may occur, which disappear again when the temperature is again within the guaranteed parameters.

A TAILORED SOLUTION

Each pair of N/S poles generates an autonomous and defined force which is not influenced by the operating conditions of the other adjacent poles. Therefore by counting the number of poles occupied by the clamped piece it is possible to predetermine the force generated and consequently to establish the usable machine power with the relative machining parameters.

1) STOCK REMOVAL CURVE / SURFACE CONDITION

(WORKPIECE ON MAGNETIC CLAMPING PLATE)

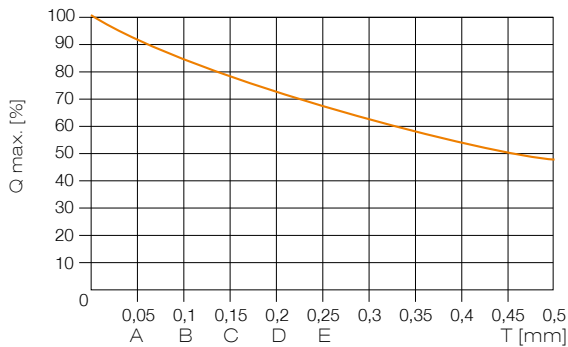

- A = milled
- B = rough-sized
- C = stamped / rolled
- D = shell casting
- E = sand casting

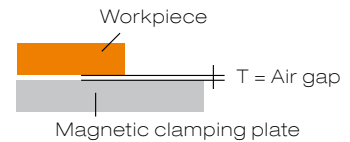

2) CURVE FOR STOCK REMOVAL / EXTENSIONS HEIGHT

(WORKPIECE ON POLE EXTENSIONS)

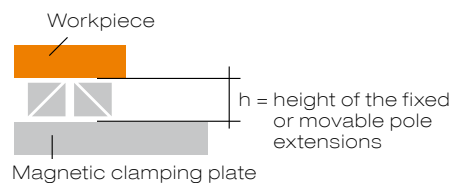
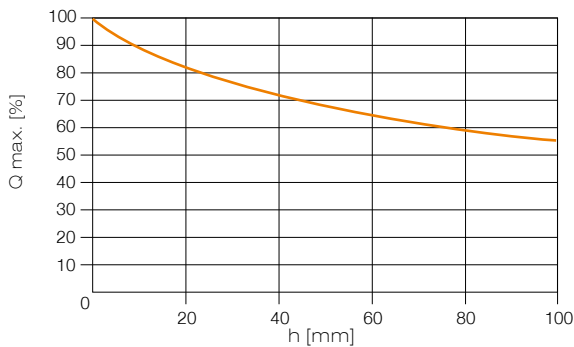

FREE SURFACES AND EVEN CLAMPING - IDEAL CONDITIONS FOR THE MOST VARIED OF APPLICATION AREAS.

No matter how different the requirements are - AMF magnetic clamping plates distinguish themselves through constantly strong performance. Heavy-duty machining with vertical or horizontal positioning can be performed just as successfully as high-speed cutting (HSC). The versatility of the system shows itself in the wide array of application options: the system is outstandingly suitable for bench type, gantry or fixed table milling machines, on machining centres, on pallets and cube tooling. Moreover, the modular design permits expansion for complete machine tables or also for special individual solutions.

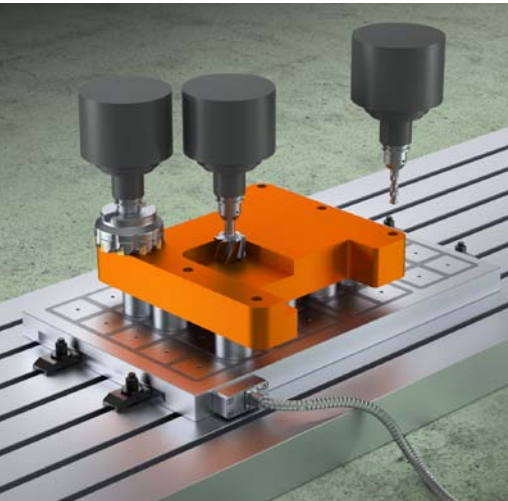

Face milling, drilling and pocket execution

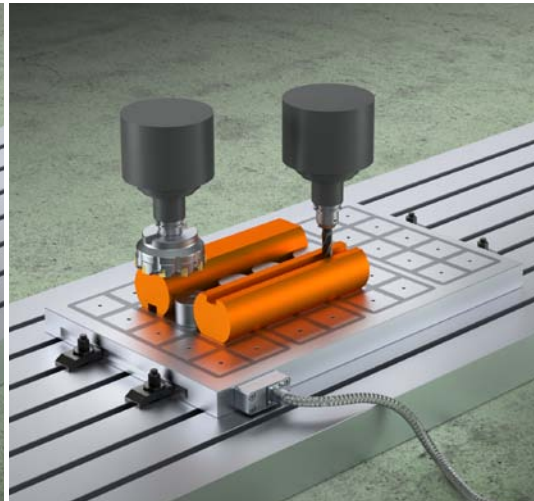

Round bar facing and slots milling

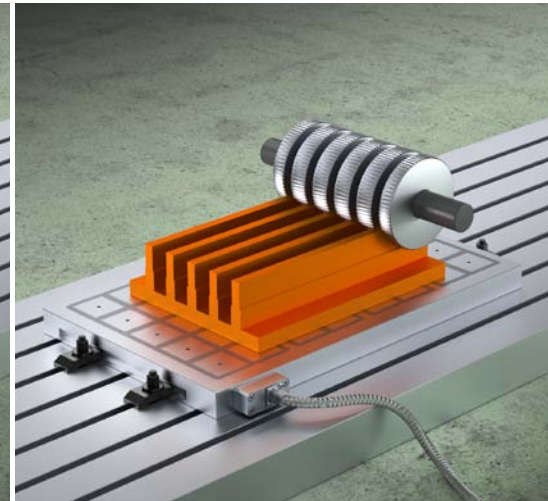

Milling multiple coupled parts

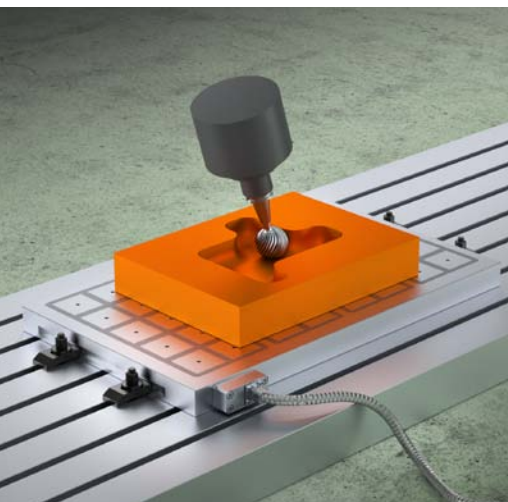

Shaping and contour cutting

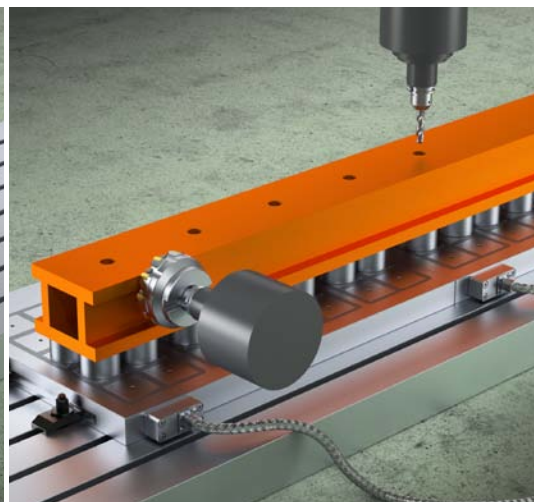

Machining of profile and rod material

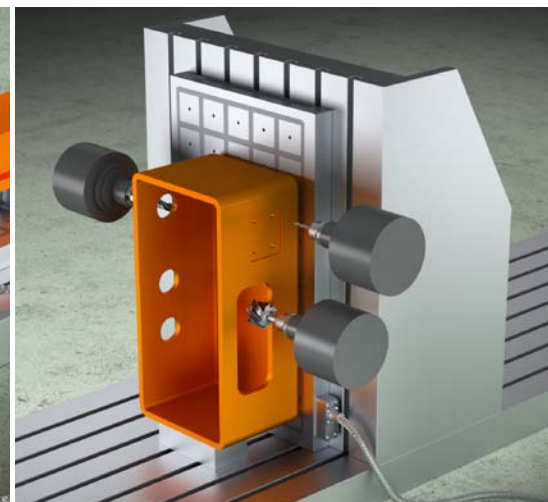

Cutting of metallic materials

MAGNETIC CLAMPING TECHNOLOGY - DEPENDENCE ON THE HOLDING FORCE OF THE MATERIAL

The share of ferromagnetic material in the workpiece is critical for the holding force when clamping on a magnetic clamping plate. The following graphic shows the percentage of achievable holding when clamping various materials.

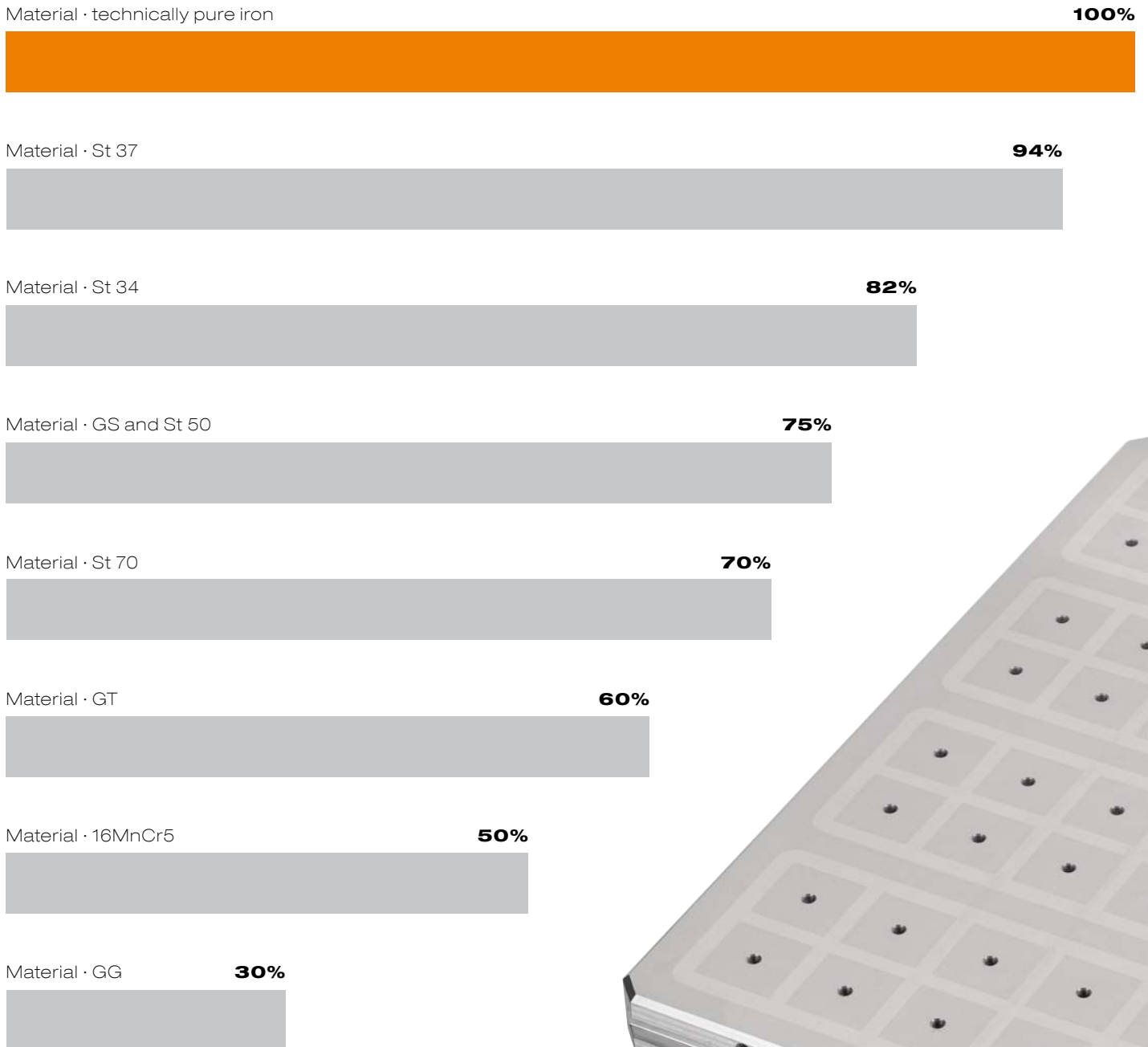

No. 2950-50

Magnetic clamping plate for milling Premium Line

Force / pole = 4 kN



Order no.	A [mm]	B [mm]	A1 [mm]	B1 [mm]	H ±0.02 [mm]	Pole size [mm]	Number of poles [St]	Holding force, max. [kN]	Weight [Kg]
559634	490	295	417	230	43	50	24	96	34
559635	490	420	417	351	43	50	36	144	49
559636	490	475	417	411	43	50	42	168	56
559637	490	575	417	504	43	50	48	192	67
559638	640	295	570	230	43	50	32	128	45
559639	640	420	570	351	43	50	48	192	64
559640	640	475	570	411	43	50	56	224	73
559641	640	575	570	504	43	50	64	256	88
559642	795	295	723	230	43	50	40	160	56
559643	795	420	723	351	43	50	60	240	80
559644	795	475	723	411	43	50	70	280	90
559645	795	575	723	504	43	50	80	320	110
559646	950	295	877	230	43	50	48	192	67
559647	950	420	877	351	43	50	72	288	96
559648	950	475	877	411	43	50	84	336	108
559649	950	575	877	504	43	50	96	384	131

Design:

Magnetic chuck with square pole technology in monoblock design and very strong holding forces. For positioning, clamping and machining magnetisable materials. In conjunction with pole extensions also particularly suitable for the 5-sided machining of workpieces.

Features:

Magnetic clamping plate with metallic surface. This special and high-quality design enables the strongest holding forces to be reached in magnetic clamping technology with square pole technology. The maximum specified holding force is effective when all poles are occupied.

A special advantage is the low construction of 43 mm. As a result, the own weight is very low, and the load on the machine table is markedly reduced.

In case of possible damage, the surface can be reworked up to 4 mm to restore the original surface quality.

The magnetic clamping plates have a height tolerance of ± 0.02 mm in the delivered condition, but an even smaller height tolerance can be offered at any time on request.

The plug contact for the control unit is a bayonet plug IP 65 incl. protective cover.

The optimal holding force is achieved with a workpiece or material thickness greater than 12 mm.

A clamping slot is also available on both sides of the faces for fastening to the machine table.

Likewise, fastening bores can be made in the magnetic clamping plates. A bore plan from AMF must be requested for this.

Advantage:

- Magnetic clamping plate with metallic surface
- Environmentally friendly clamping technology: power is only needed for clamping and unclamping
- Maximum safety: holding force remains in place even in a power failure
- Maximum holding force: through the use of the latest magnetic materials
- Very low installation height
- Water-resistant plug IP 65

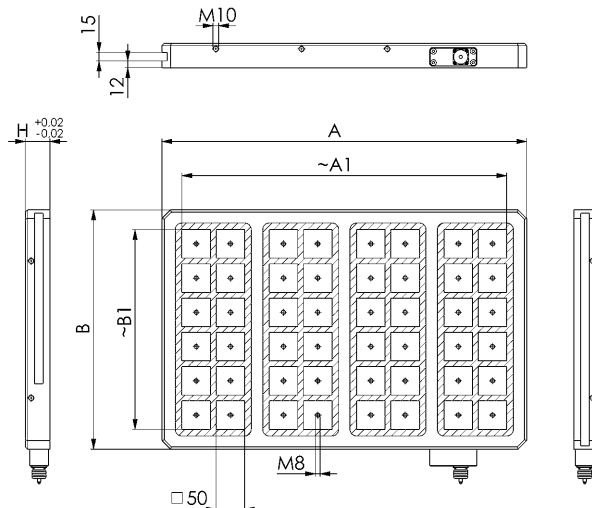

CAD



Subject to technical alterations.

No. 2990-50

Magnetic clamping plate for milling Eco Line

Force / pole = 4 kN

Order no.	A [mm]	B [mm]	A1 [mm]	B1 [mm]	H ±0,1	Pole size [mm]	Number of poles [St]	Holding force [t]	Weight [Kg]
559718	580	390	250,5	310,5	43	50	40	16,0	68,0
559719	780	390	310,5	310,5	43	50	50	20,0	79,0

Design:

Magnetic clamping plate with square pole technology in monoblock design.
For positioning, clamping and machining magnetisable materials.

Features:

This special and high-quality design enables reaching of a very high holding force.
The maximum specified holding force is effective when all poles are occupied.
In case of possible damage, the surface can be reworked up to 4 mm to restore the original surface quality.
The magnetic clamping plates have a height tolerance of + / - 0.1 mm in the delivered condition.
The plug contact for the control unit is a bayonet plug IP 65 incl. protective cover.
The optimal holding force is achieved with a workpiece or material thickness greater than 12 mm.
A clamping slot is also available on both sides of the faces for fastening to the machine table.
Likewise, fastening bores can be made in the magnetic clamping plates. A bore plan from AMF must be requested for this.

Advantage:

- Very low installation height
- Environmentally friendly clamping technology: power is only needed for clamping and unclamping
- Maximum safety: holding force remains in place even in a power failure
- Maximum holding force: through the use of the latest magnetic materials
- Water-resistant plug IP 65

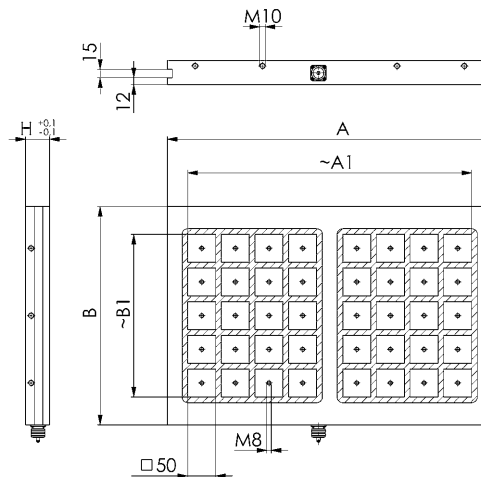
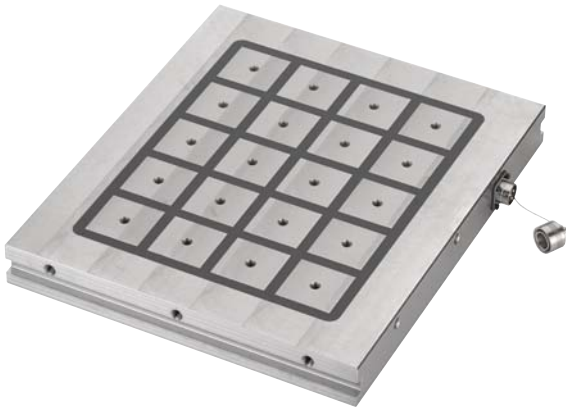

PERFECTLY EQUIPPED IN MAGNETIC CLAMPING TECHNOLOGY - A COMPLETE SOLUTION FOR INCREASING YOUR OPERATING TIMES

The magnetic clamping plates from AMF represent technological peak performance in electric permanent magnetism applied to mechanical processing. They allow a large variety of ferrous parts to be clamped quickly and flexibly, on virtually any type of machine tool. The systems are powerful, lightweight, compact, easy to install and to use.

The economic advantages through the use of AMF magnetic clamping technology speak for themselves:

- > Quick amortisation of your investment with large, immediate successes
- > Drastic reduction of your production costs
- > No installation of expensive and sensitive devices
- > No use of machines that are larger than necessary
- > Free space is created, investments are limited, and productivity is increased.

With our "magnetic clamping" special offer packages, we offer you a complete solution for all milling work. The areas of application are practically unlimited. Thin or non-geometrical workpieces can be machined without difficulty. For heavy-duty milling or in the high-speed range (HSC), AMF magnetic clamping technology represents a practical, flexible, and above all safe type of clamping.

THE SPECIAL OFFER PACKAGES

PACKAGE 1

HOLDING FORCE **8 t**

PACKAGE 2

HOLDING FORCE **16 t**

PACKAGE 3

HOLDING FORCE **20 t**

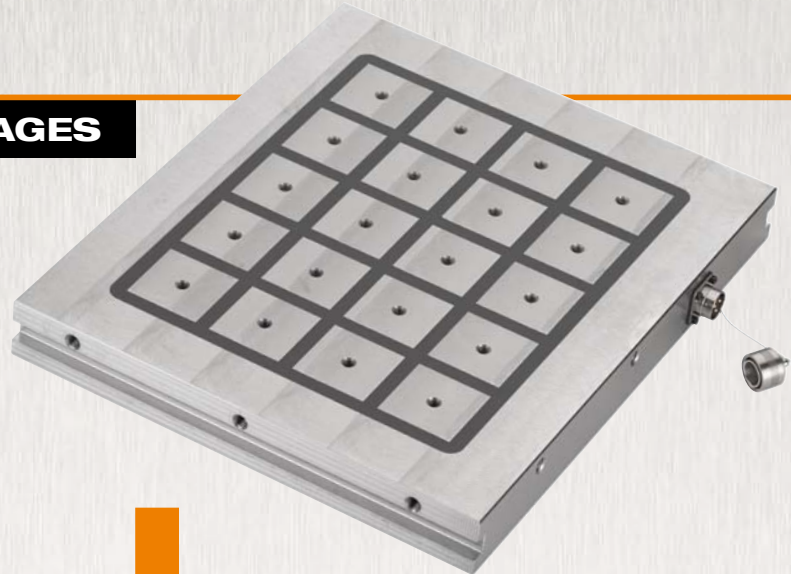

Subject to technical alterations.

THE MAGNETIC CLAMPING SPECIAL OFFER PACKAGES - FAST, SAFE AND ECONOMICAL CLAMPING OF YOUR WORKPIECES

The AMF magnetic clamping systems convince users through easy setup in combination with extremely high holding forces and the advantage of five-side processing. The magnetic clamping plates are used for both heavy milling work and in the high-speed range (HSC) - and this completely without any interfering edge.

Optimal adaptation to the workpiece surface contour is guaranteed by the movable pole extensions. These pole extensions adapt themselves to the workpiece surface. The workpiece is supported and rests securely on the pole extensions. This compensates for uneven surfaces and clamps the workpiece without tension.

No. 2992-50

Magnetic clamping special offer package

Order no.	Set	A [mm]	B [mm]	A1 [mm]	B1 [mm]	H ±0,1	Pole size [mm]	Number of poles [St]	Holding force [t]	min. workpiece thickness [mm]	Weight [Kg]
559720	1	390	330	310,5	250,5	43	50	20	8,0	12,0	55,0
559721	2	580	390	250,5	310,5	43	50	40	16,0	12,0	96,0
559726	3	780	390	310,5	310,5	43	50	50	20,0	12,0	111,0

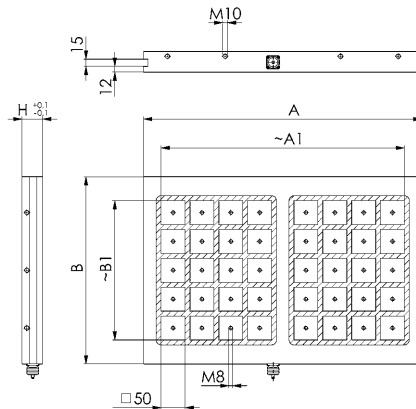
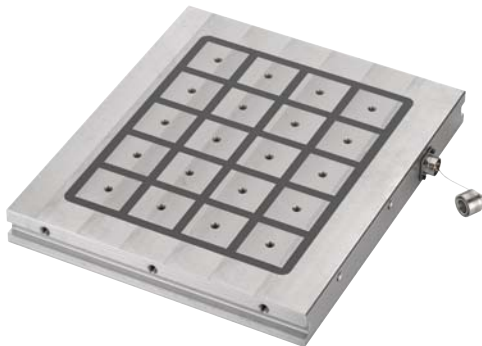

Pole extensions



Contents / Technical data of the special offer packages:

Set	Number of pole extensions [pcs.]	Fixed pole extensions [pcs.]	Mobile pole extensions [pcs.]	Weight [kg]
1	20	3	17	8,8
2	40	6	34	17,6
3	50	6	44	20,3

Control unit



Set	Number of magnetic clamping plates to control [St]	Weight [kg]
1+2+3	1	10,0

Optimal adaptation to the workpiece surface contour is guaranteed by the movable pole extensions. These pole extensions adapt themselves to the workpiece surface. The workpiece is supported and rests securely on the pole extensions. Optimal machining is possible from 5 sides without any interference contours.



No. 2975PF-50

Pole extension, fixed

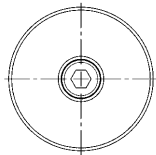
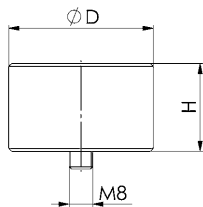

Order no.	Size	dia. D [mm]	H [mm]	Weight [g]
550745	50	49	30	438

Application:

Fixed pole extensions are attached directly to the poles of the magnetic clamping plate with an M8 screw. Pre-processed or flat workpieces can be placed directly on the fixed pole extensions and clamped. If the workpiece has uneven surfaces, it is usually placed on 3 fixed pole extensions and clamped (three-point bearing). Movable pole extensions, which adapt flexibly to the workpiece contours, are fastened onto all other poles.

Features:

The pole extensions are designed for the optimum magnetic flux through the pole extension into the workpiece. The M8 fastening screw is supplied as standard.

Advantage:

- Easy and quick installation
- Optimum power flux of the magnetic field lines
- Strong holding forces

No. 2975PFD-50

Pole extension with friction coefficient increase, fixed

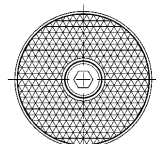
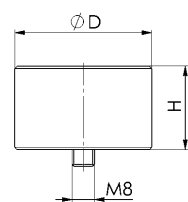

Order no.	Size	dia. D [mm]	H [mm]	Weight [g]
566550	50	49	30	440

Application:

Fixed pole extensions are attached directly to the poles of the magnetic clamping plate with an M8 screw. Pre-processed or flat workpieces can be placed directly on the fixed pole extensions and clamped. If the workpiece has uneven surfaces, it is usually placed on 3 fixed pole extensions and clamped (three-point bearing). Movable pole extensions, which adapt flexibly to the workpiece contours, are fastened onto all other poles.

Features:

The pole extensions with increased friction coefficient can be used in many ways. With up to 250% higher shear force load, the specially coated pole extension works well in many areas of use. The M8 fastening screw is supplied as standard.

Advantage:

- Easy and fast installation
- Very high shear force load possible, even without stops

Note:

A combination of fixed pole extensions with (566550) and without increased friction coefficient (550745) is not possible.

No. 2975PF

Pole extension, multiple, fixed

NEW!

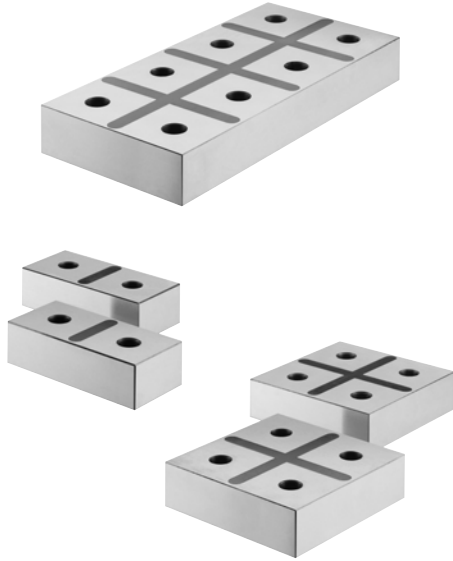

Order no.	Number of poles [St]	Arrangement	fits	A [mm]	B [mm]	H ±0.05 [mm]	Pole size [mm]	Weight [g]
565084	2	2 x 1	-	110	50	30	50	1180
565085	4	2 x 2	-	110	110	30	50	2500
565086	6	2 x 3	-	110	170	30	50	3600
565980	8	2 x 4	795x575 / 795x295 / 640x295 / 490x295 / 490x475 / 640x575 / 950x295 / 950x575	110	230	30	50	4840
565981								
565982	14	2 x 7	795x475 / 640x475 / 490x475 / 950x475	110	410	30	50	8600
565983	20	4 x 5	2990 - 390x330 / 580x390	230	290	30	50	12000
565984	25	5 x 5	2990 - 780x390	290	290	30	50	15000

Application:

Fixed pole extensions with pole division for multiple poles. The surface can be worked on as desired; for example, the negative contour of the workpiece to be processed can be brought in.

Features:

The pole extensions are designed for optimum magnetic flux. The M8 fastening bolts are supplied as standard.

Advantage:

- Easy and fast installation
- Optimal force flow of the magnetic field lines

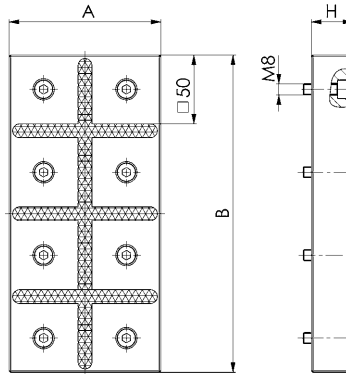

No. 2975PB-50

Pole extension, movable

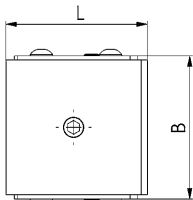
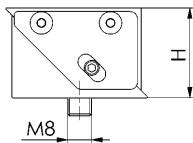

Order no.	Size	L [mm]	B [mm]	H [mm]	Weight [g]
550746	50	49	48	28 - 32	440

Application:

Moveable pole extensions are attached directly to the poles of the magnetic chuck with an M8 screw. On uneven materials the movable pole extensions are used for height adjustment and adapt to the workpiece by means of spring force. Workpieces can be mounted and clamped warp-free.

Features:

The pole extensions are designed for the optimum magnetic flux through the pole extension into the workpiece. The M8 fastening screw is supplied as standard.

Advantage:

- Easy and quick installation
- Optimum power flux of the magnetic field lines
- Strong holding forces

No. 2970SGH-10

Control unit for a magnetic clamping plate

NEW!



Order no.	Length [mm]	Width [mm]	Height [mm]	Weight [Kg]
561438	300	250	210	12

Application:

Control unit for a magnetic clamping plate.

The control unit has three operating keys:

- 1 x Magnetisation (MAG)
- 1 x Demagnetisation (DEMAG)
- 1 x Release

To start the magnetisation or demagnetisation cycle, the following button combinations must be pressed simultaneously:

- Magnetisation = MAG + Release
- Demagnetisation = DEMAG + Release

Features:

The connection cable and control lead have a length of 3 metres each. The connection cable has a plug for 400V / 32A and is pre-installed ready for connection. The high-quality control cable has a sheathing made of steel mesh and an IP65 bayonet connector for connection to the magnetic clamping plate.

The control unit can optionally be controlled with the hand-held controller. Connection to machine PLC is possible. The control unit has a prepared cable bushing for the machine locking device signal. The holding force of the magnetic clamping plate can also be set with our hand-held controller 562876.

Advantage:

- Compact and connection-ready controller for a magnetic clamping plate
- Short cycle times (approx. 1 second) for magnetisation or demagnetisation
- No further installation necessary, such as of a connector plug
- Very solid and robust construction

No. 2970SGH-20

Control unit with channel selection incl. holding force regulation

NEW!



Order no.	Number of magnetic clamping plates to control [St]	Length [mm]	Width [mm]	Height [mm]	Weight [Kg]
565374	1 - 2	400	300	210	15
561439	1 - 4	400	300	210	18

Application:

Control unit with hand-held controller for the activation of 1-2 or 1-4 magnetic clamping plates. The individual plates can be selected and removed with the hand-held controller. In addition, it controls the holding force regulation and also the system analysis.

To start the magnetisation or demagnetisation cycle, the following key combinations must be pressed simultaneously:

- Magnetisation = MAG + Release
- Demagnetisation = DEMAG + Release

Features:

The connection cable and control lead have a length of 6 metres each. The connection cable has a plug for 400V / 32A and is pre-installed ready for connection. The high-quality control cable has a sheathing made of steel mesh and an IP65 bayonet connector for connection to the magnetic clamping plate.

The hand-held controller is supplied as standard. It can be used to set the holding force, if desired. The control unit has a prepared cable bushing for the machine locking device signal.

Advantage:

- Compact and connection-ready controller for 1-2 or 1-4 magnetic clamping plates
- Short cycle times less than 1 second for magnetisation or demagnetisation
- Including hand-held controller as remote control for convenient handling
- No further installation necessary, such as of a connector plug
- Very solid and robust construction

No. 2970HBG-H10

Hand-held controller for magnetic clamping technology

NEW!



Order no.	Length of connecting cable		Weight [Kg]
	[m]		
563933	3		1,0

Application:

The hand-held controller is used to control the magnetic clamping plates through the control unit. The hand-held controller has three function buttons:

- 1 x Magnetisation (MAG)
- 1 x Demagnetisation (DEMAG)
- 1 x Release

To start the magnetisation or demagnetisation cycle, the following button combinations must be pressed simultaneously:

- Magnetisation = MAG + Release
- Demagnetisation = DEMAG + Release

Features:

The hand-held controller works with all AMF control units of the series 2970SGH and is connected directly to the control unit by means of a plug connection. The connection cable is 3 m long.

Advantage:

- Light and practical hand-held controller
- Connection-ready delivery
- Can be connected directly to the control device or control unit
- Magnetic-foil attached to the back for easy handling

No. 2970HBG-H10R

Hand-held controller for magnetic clamping technology incl. holding force regulation

NEW!



Order no.	Length of connecting cable		Weight [Kg]
	[m]		
562876	3		1,0

Application:

The hand-held controller is used to control the magnetic clamping plates through the control unit. The holding force regulation allows individual reaction to all circumstances.

To start the magnetisation or demagnetisation cycle, the following key combinations must be pressed simultaneously:

- Magnetisation = MAG + Release
- Demagnetisation = DEMAG + Release

Features:

The hand-held controller works with all AMF control units of the series 2970SGH and is connected directly to the control unit by means of a plug connection. The connection cable is 3 m long.

Advantage:

- Including the functions: holding force regulation, channel selection and system evaluation
- Connection-ready delivery
- Can be connected directly to the control device or control unit
- Magnetic-foil attached to the back for easy handling



These Terms of Payment apply for companies, legal entities governed by public law and public law special funds. Our goods and services are supplied exclusively on the basis of the following conditions. Any deviating purchasing conditions of the customer not expressly recognised by us will not become part of the contract through acceptance of the order. By placing the order and accepting the goods we deliver, the customer confirms its consent to our terms and conditions.

1. Offer and contractual conclusion

All our offers are always subject to change without notice unless otherwise explicitly agreed. Our delivery contracts are based on the latest version of our catalogue. Dimension and weight values, as well as illustrations, drawings and data, are non-binding and can be changed by us at any time. Therefore, deviations cannot be ruled out and do not justify any compensation claims against us.

Orders are considered accepted only when confirmed by us in writing. If, for organisational reasons, the customer does not receive a separate confirmation upon the delivery of goods, the invoice shall also be deemed the order confirmation.

2. Prices

The prices are in EURO, ex-works, excluding VAT, packing, freight, postage and insurance. Unless otherwise agreed, our list prices valid on the day of delivery shall apply. For orders below 50 EUR goods net, we must make a minimum quantity surcharge of a 10 EURO for cost reasons.

3. Tool costs

Unless any other agreements have been reached, the tools fabricated for the purpose of executing the order shall remain our property in all cases, even if we have invoiced a tool cost component separately.

4. Payment

Unless otherwise stated on the invoice, the purchase price falls due for net payment within 30 days of the invoice date (without deduction of discount). Invoice amounts of below 50 EURO are due for payment immediately.

In case of payment default, we shall be entitled to charge default interest. The amount corresponds to our interest rate for current account credits at our main bank; the minimum however being 8 percentage points above the relevant base interest rate applied by the European Central Bank. Moreover, in case of default following written notice to the customer, we shall be entitled to cease to fulfil our obligations until payments are received.

5. No set-off

The customer can set-off only with legally confirmed or undisputed counterclaims.

6. Right of withdrawal in case of delayed acceptance or payment and insolvency

If the customer fails to accept the goods in due time, we shall be entitled to set a reasonable period of grace, after which we can dispose of the goods elsewhere and supply the customer on a reasonably longer term. Our rights to withdraw from the contract under the provisions of Section 326 BGB and demand damages for non-performance shall not be affected. If the customer fails to pay for the goods once payment is due, we shall be entitled, at the end of a reasonable period of grace we have set, to withdraw from the contract and demand the return of any goods already supplied. Section 323 BGB remains unaffected in all other cases.

If the customer applies for the opening of insolvency proceedings, we shall be entitled, prior to the ordering of security measures by the insolvency court, to withdraw from the contract and demand the immediate return of the goods.

7. Customer-specific fabrications/project fabrications (custom fabrications)

Customer-specific fabrications require binding information on design, quantity etc. in written form at the time of ordering. For manufacturing reasons, we reserve the right to supply up to 10% above or below the order quantity. Technical modifications or cancellations are subject to any costs incurred. The return of customer-specific fabrications is impossible.

8. Delivery and packaging, transfer of risk

The delivery date is non-binding; although stated to the best of our knowledge. It is subject to us receiving correct, defect-free and complete deliveries. The stated delivery dates relate to completion in the factory, starting on the day the order is accepted by us. Delivery is EXW (ex-works) in accordance with Incoterms 2010. Therefore, the costs are borne by the customer. The risk is transferred to the customer when the goods are passed to the person, company or facility nominated to execute the shipment. This applies also for partial deliveries, or if we have assumed responsibility for delivery and installation. The risk shall be transferred to the customer even in the case of delayed acceptance.

In the absence of specific shipping instructions, we shall proceed as we deem fit and without any obligation to the cheapest or most expedient method. The customer agrees that the order can also be delivered in parts, insofar as this is reasonable for the customer. We shall charge a 5 EURO processing free for shipping to third parties that we supply on behalf of the customer.

The packaging complies with the packaging ordinance. Disposable packaging shall be charged at cost price. The packaging cannot be taken back.

9. Performance impediment and/or impossibility

If we are hindered in the fulfilment of our obligation due to the onset of unforeseeable circumstances, which we are unable to avoid despite reasonable effort in relation to the nature of the circumstances (e.g. operational interruption, delay in the delivery of important raw materials, defects in the delivery), the delivery time shall be extended by a reasonable period, insofar as the supply of goods or services is not rendered unreasonably difficult or impossible.

If we have to accept that these circumstances are not only temporary, we shall be entitled to withdraw from the contract either in whole or in part.

If the supply of goods or services becomes impossible, the customer shall not be obliged to furnish its own contractual service. Section 275 BGB applies mutatis mutandis. If, however, the customer is solely or predominantly responsible for the

circumstances that led to impossibility, it shall remain under an obligation to render the return service. The same applies if this circumstance occurs at a time when the customer is behind schedule with acceptance.

10. Samples/returns

Samples shall be provided only against payment. If samples or models are provided, a credit note shall be issued with the subsequent order if the order value is 125 EURO net or more. Goods can be returned only by agreement, although custom fabrications are excluded from such return.

In the case of returns for which we are not responsible (e.g. incorrect order), we shall charge a processing fee of 10%, the minimum value, however, being 7.50 EURO.

11. Retention of title

The goods shall remain our property unless full payment of all claims and/or until the cheques provided for this purpose are honoured. The itemisation of claims in an ongoing invoice, as well as balancing the account and the recognition thereof does not affect the retention of title. The customer is entitled to sell on the retained goods during the ordinary course of business. However, the customer is not permitted to pledge the goods or transfer them by way of security. It shall assign its claim ensuing from the selling on of the retained goods to us in advance. The customer shall be entitled to collect the claim to the extent that it has fulfilled its obligations towards us. At our request, the customer shall be obliged to state third-party debtors and we shall be entitled to report this and the assignment.

12. Property rights

We reserve property rights and copyrights to all contractual documents such as drafts, drawings, calculations and cost estimates. Such documents must not be reproduced or disclosed to third parties without our consent. Any rights to patents, utility models etc. reside solely with us, insofar as such patents have not yet been filed. Our products are allowed to be replicated only with our written consent.

If objects are fabricated according to drawings or samples, the customer shall warrant that any third party property rights are not infringed by manufacture or delivery. If a third party forbids manufacture and delivery on account of property rights, we shall be entitled to stop manufacture and delivery immediately. The customer shall be obliged to reimburse us with all costs incurred and indemnify us from third party compensation claims. Compensation claims by the customer are impossible.

13. Warranty

If the customer agrees with us a particular quality of the goods, we shall base this agreement on our technical delivery specifications. If we have to deliver according to customer drawings, specifications, samples etc., the customer shall assume the risk for suitability for the intended purpose. If, after the contract is concluded, the scope of goods or services is changed at the customer's request and this impairs the quality or suitability of the goods, claims for defects on the part of the customer shall be ruled out, insofar as such impairments are caused by the customer's requests for change.

The time at which the risk is transferred is decisive for the contractual state of the goods. Wear and tear of wearing parts caused by ordinary use does not constitute a defect. Claims for defects are ruled out in the following cases in particular: Unsuitable or improper use, incorrect installation and/or commissioning by the customer or third party, normal wear and tear, incorrect or negligent handling - in particular excessive use -, unsuitable equipment, replacement materials, chemical, electrochemical or electrical influences, unless such defects are caused by ourselves.

If the goods contain a defects, we shall provide, following a reasonable period of grace set by the customer, either a replacement or a repair as we deem fit. If such subsequent performance fails, the customer shall be entitled to either reduce the purchase price or withdraw from the contract. Any further warranty claims are ruled out. In case of negligible deviations from the agreed quality, no claims for defects shall be recognised.

The discovery of defects must be communicated to us immediately in writing. In the case of recognisable defects, however, within 10 days of acceptance, in the case of non-recognisable defects immediately after they become evident. The warranty is 12 months, starting with delivery of the goods ex-works.

14. Liability

With the exception of harm to life, body or health on account of a breach of duty by ourselves, our liability shall be limited to intent or gross negligence.

15. Place of fulfilment, place of jurisdiction and governing law

The place of fulfilment for all obligations ensuing from this contractual relationship is D-70734 Fellbach.

The place of jurisdiction for all legal disputes ensuing from the contractual relationship is the court responsible for the headquarters of Andreas Maier GmbH & Co. KG.

All disputes ensuing from the contract or regarding the validity thereof shall be finally decided by a court of arbitration in accordance with the Court of Arbitration Ordinance of the German Committee for Arbitration Court Procedures or the Conciliation and Arbitration Arrangement of the International Chamber of Commerce, recourse to ordinary courts of law being excluded. The legal dunning process, however, remains permissible.

German law shall govern (BGB and HGB). The applicability of the UN Convention on Contracts for the International Sale of Goods (CISG) is ruled out.

16. Severability clause

If individual provisions become legally invalid, the remaining provisions shall not be affected. The legally invalid provision shall be replaced by regulations that most closely reflect the economic purpose of the contract with reasonable consideration for the mutual interests. The publication of these Terms of Sale, Delivery and Payment renders all previous versions invalid. This does not apply for any contracts concluded prior to announcement.

MAGNETIC CLAMPING SYSTEMS CATALOGUE 2022/2023

Request additional catalogues from www.amf.de



ZERO-POINT-SYSTEMS



HYDRAULIC CLAMPING SYSTEMS



VACUUM CLAMPING SYSTEMS

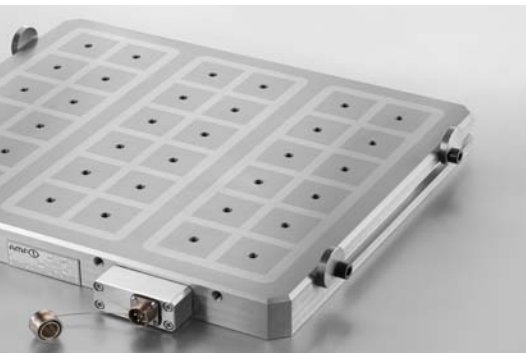

MAGNETIC CLAMPING SYSTEMS



WIRELESS SENSING SYSTEMS



TOGGLE CLAMPS

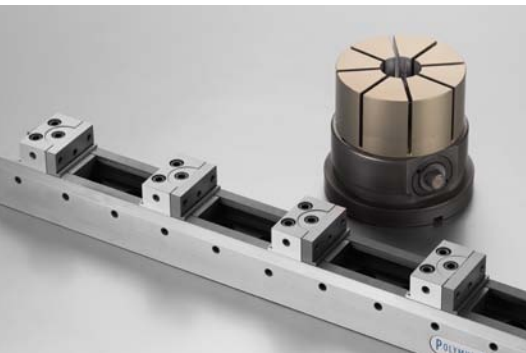

SINGLE AND MULTIPLE CLAMPING SYSTEMS



STANDARD CLAMPING SYSTEMS



MARKING AND CLEANING TOOLS



ANDREAS MAIER GmbH & Co. KG

Waiblinger Straße 116 · D-70734 Fellbach

Phone: +49 711 5766-0

Fax: +49 711 575725

E-mail: amf@amf.de

Web: www.amf.de

Order no. 466003 · € 2,40